

## VORTICEL E RANGE

Low pressure plate axial fans

### PRODUCT SPECIFICATIONS

*Suitable for commercial and industrial applications as garages, warehouses, gyms, dry cleaners, carpentry workshops, etc.*

- **7 models** 4 single-phase and 3 three-phase.
- Frames equipped with air intake with aerodynamic section, made using sheet steel protected with polyester paint.
- Class F ball bearing motors.
- Impellers with optimized blades profiles to reduce noise caused by turbulence, made of shock-proof polypropylene. All die-cast aluminium hubs.
- Protective grilles made of steel rings, black epoxy polyester painted, removable for maintenance and cleaning purpose.
- Wide range of continuous operation temperatures between -25°C and +50/+70 °C.
- Electric supply 220-240 V / 50 Hz for single phase models, 380-415 V / 50 Hz for three phase models.
- Motor protection rating: IP44.
- Insulation class: I.

Fans used in VORTICEL E range comply with ErP Lot. 6 Reg. N° 327/2011/UE.



LONG LIFE 30.000 h

### TECHNICAL DATA

	Models	Code	V ~ 50 Hz	W	A	Poles	RPM	Max Airflow		Max Pressure		Lp dB(A) 3 m*	°C Max	Kg
								m³/h	l/s	mmH₂O	Pa			
SINGLE-PHASE	E 252 M	40203	220 - 240	95 - 105	0.45 - 0.47	2	2800	1500	416.7	20	196	71	70	3.5
	E 254 M	40303		55 - 65	0.31 - 0.39			1000	277.8	6.7	66	50.5	60	
	E 304 M	40503		55 - 70	0.33 - 0.40			1360	377.8	7.5	74	54	65	
	E 354 M	40703		85 - 95	0.44 - 0.45			1850	514	4.6	45	66.5	65	
THREE-PHASE	E 254 T	40356	220 - 380 240 - 415	55 70	0.35/0.20 0.40/0.23	4	1400	1000	277.8	7.3	71	53	55	3
	E 304 T	40556		65 80	0.32/0.19 0.38/0.22			1400	389	8.2	81	53	50	
	E 354 T	40756		90 100	0.34/0.20 0.38/0.22			1900	528	7.1	70	61	60	

\* Sound pressure level measured at 3 m in free field conditions with long-cased appliance in delivery mode, in accordance with standard EN ISO 3741:2009.

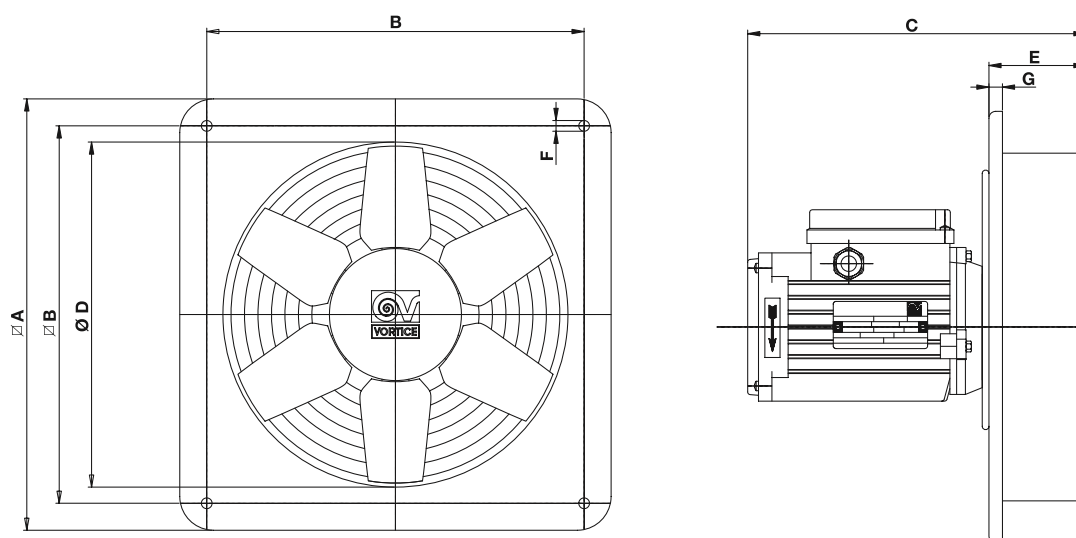

## DIMENSIONS



Models	Ø nom.	∇ A	∇ B	C	Ø D	E	Ø F	G
E 252	250	320	280	201	256	68	8	10
E 254								
E 304	315	380	330	203	308	70		
E 354	355	450	380		360			

Dimensions (mm)

## PRODUCT ACCESSORIES

Models	Description	Code	Product	
	IRM 30 - Three position single-phase speed controller	12921	40203 - 40303 - 40503 - 40703	
	IRT 15 - Three position three-phase speed controller	12923	40356 - 40556 - 40756	
	IREM 3 - Single-phase speed controller	12931	40203 - 40303 - 40503 - 40703	
	IREM 5 - Single-phase speed controller*	12932		
	IREM 9 - Single-phase speed controller**	12933		
	DPU - Spacer for panel installation	250	52151	40203 - 40303 - 40356
		300	52251	40503 - 40556
		350	52351	40703 - 40756

\* Can control several fans up to a max of 5 A.

\*\* Intended to simultaneously control appliances, up to a max of 9 A.

Description and sizes on page 162



PERFORMANCE CURVES

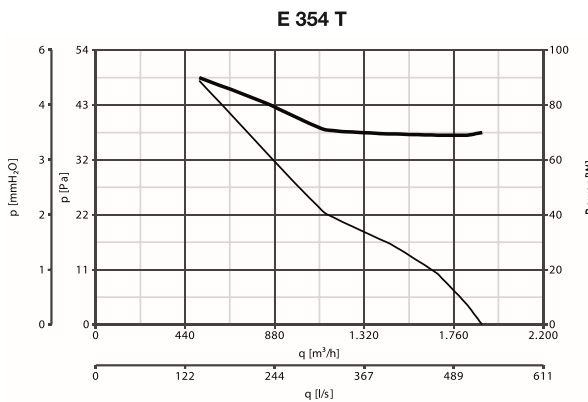
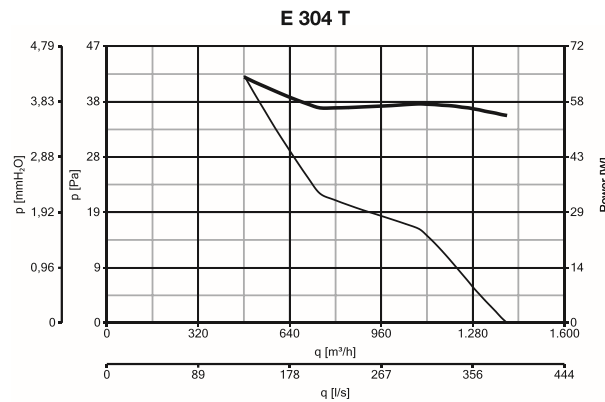
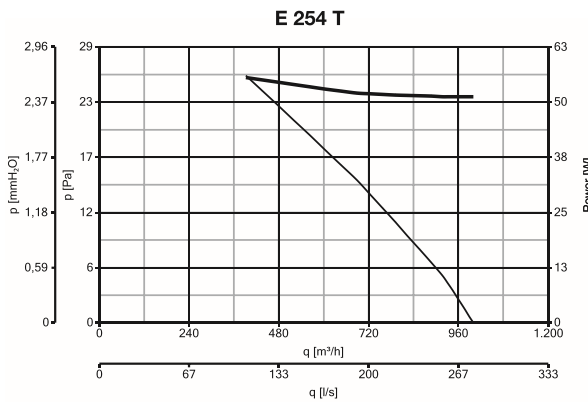
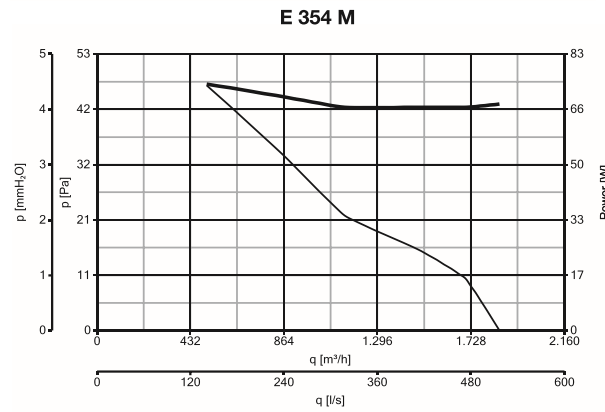
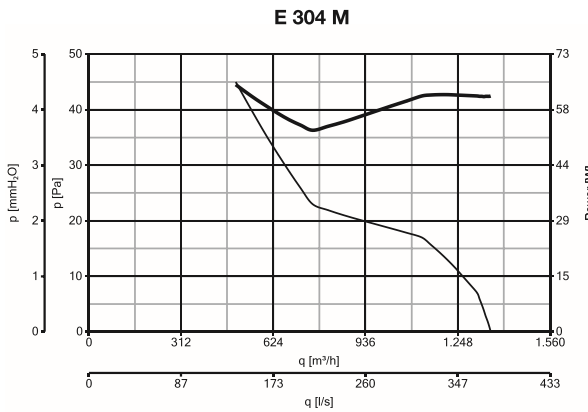
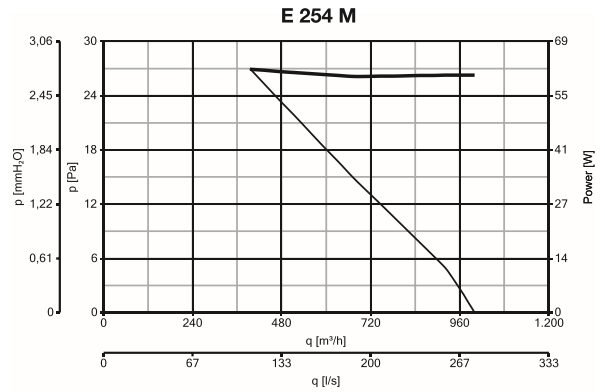
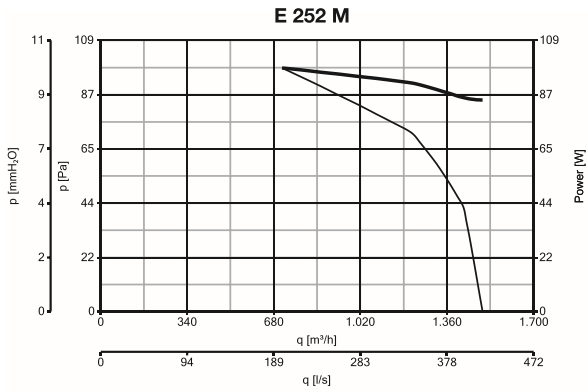

— Consumption — Delivery